

Bardzo proszę, aby uczniowie klasy pierwszej zapisali w swoich zeszytach następujące wyrazy (całą linijkę) oraz zrobili do nich ilustracje. Wg wzoru

Np. ruler ruler ruler ruler ruler ruler ruler ruler ruler ruler



ruler

schoolbag

notebook

crayon

pencil

pen

rubber

oraz proszę o zapisanie NOWYCH SŁÓW : całą linijkę, przetłumaczenie wyrazu oraz wykonanie ilustracji do zeszytu.

glue- klej



glue glue glue glue glue glue glue glue

scissors- nożyczki



scissors scissors scissors scissors scissors

sharpener- strugaczka

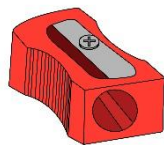

sharpener sharpener sharpener sharpener sharpener

dziękuję.

Dla chętnych osób dodatkowe zadania poniżej.

Zad. 1 Rozwiąż krzyżówkę

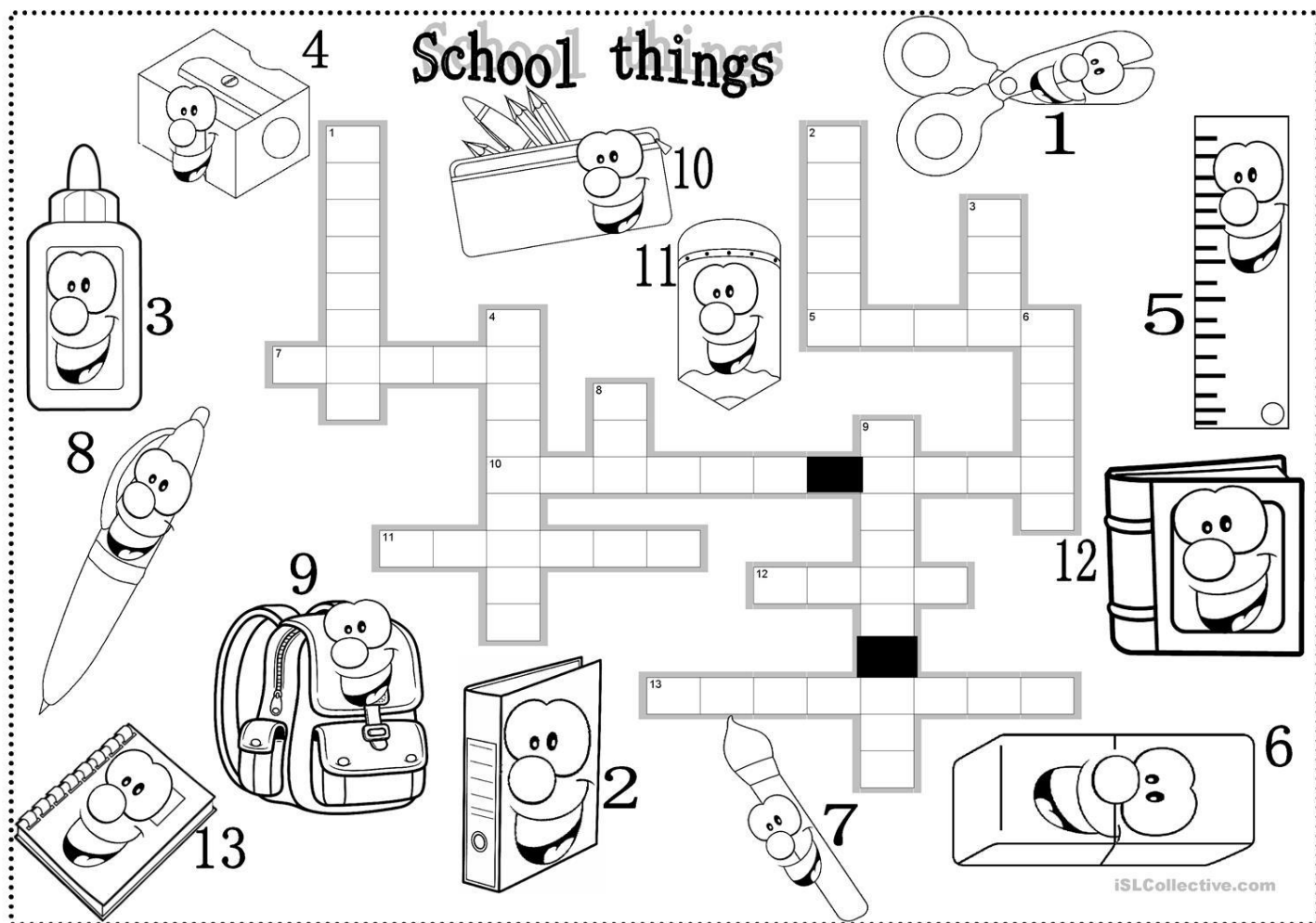

nr 2- binder (segregator)

nr 7- brush (pędzel)

Zad. 2. Z podanych liter ułóż słowa

Crazy Words



epcilm



oshole



burbre



yncaro



agb



acrehte



urelr



okob

Zad. 3. Pokoloruj wg podanych instrukcji.

(tutaj **eraser** oznacza to samo co **rubber**- czyli gumka do mazania. Eraser jest amerykańskim słowem podczas gdy w Wielkiej Brytanii używa się słowa rubber☺)

Jeżeli nie masz drukarki w domu możesz przerysować do zeszytu.

What's in
my bag?



Read and colour:
I have **1 blue** bag.
I have **3 yellow** pencils.
I have **red** scissors.
I have **2 pink** erasers.
I have **4 green** books.
I have **2 black** pens.
I have **5 orange** and **3 purple** crayons.
I have **3 purple** sharpeners

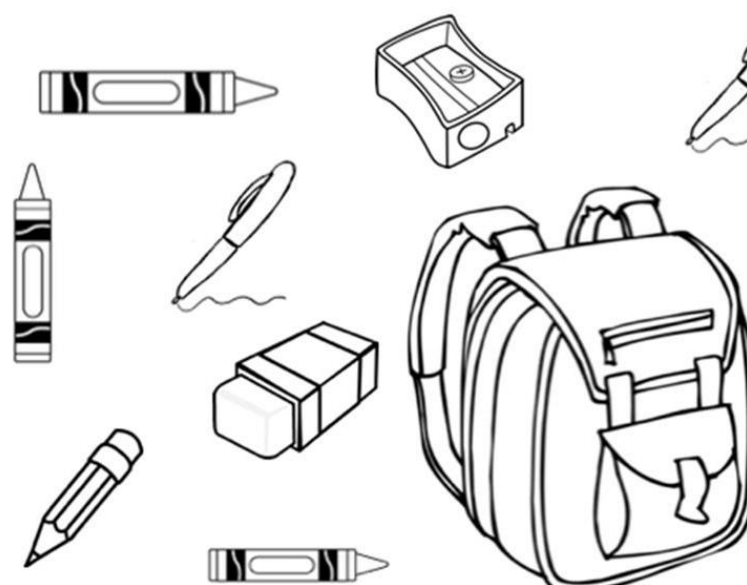
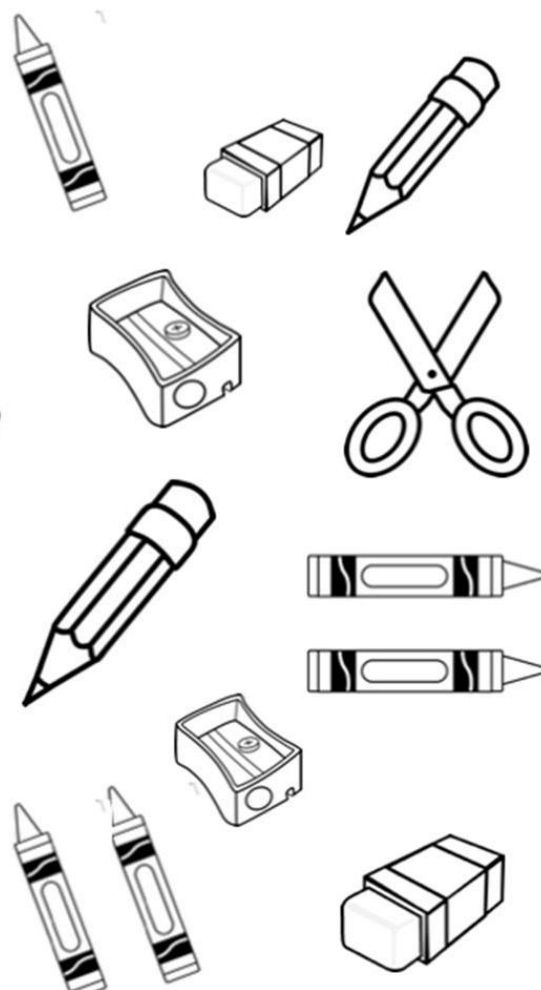

Zad. 4*. Połącz, niektóre słowa mogą być nowe.

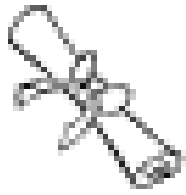

board

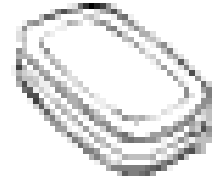

book

calculator

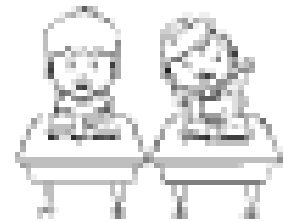

classroom

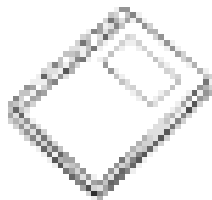

diploma



globe



map



notebook

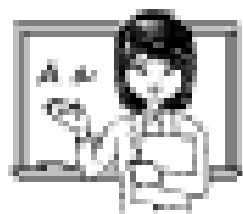

pencase

schoolbag



student



teacher

